



Installation instructions, accessories

Volvo Car Corporation Gothenburg, Sweden

Instruction No	Version	Part. No.
31346068	1.1	31350479, 31346065, 31407107

Trailer hitch, cable harness, and control module



Installation instructions, accessories

Volvo Car Corporation Gothenburg, Sweden

Equipment

VIDA

IMG-242205

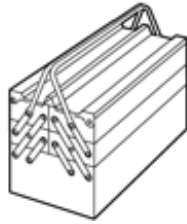

IMG-345497



IMG-332314

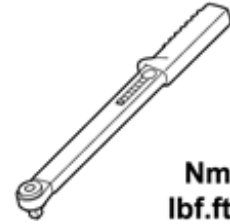

IMG-239664

Nm
lbf.ft

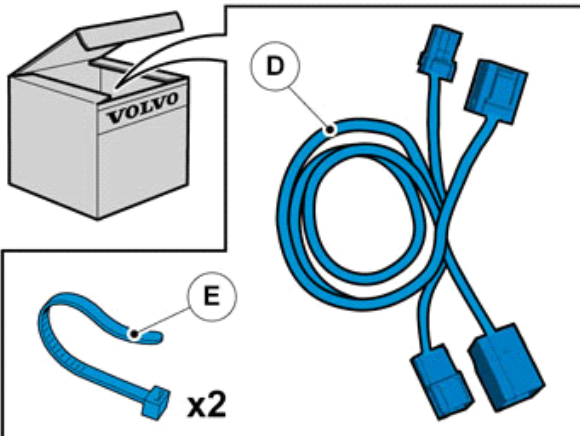
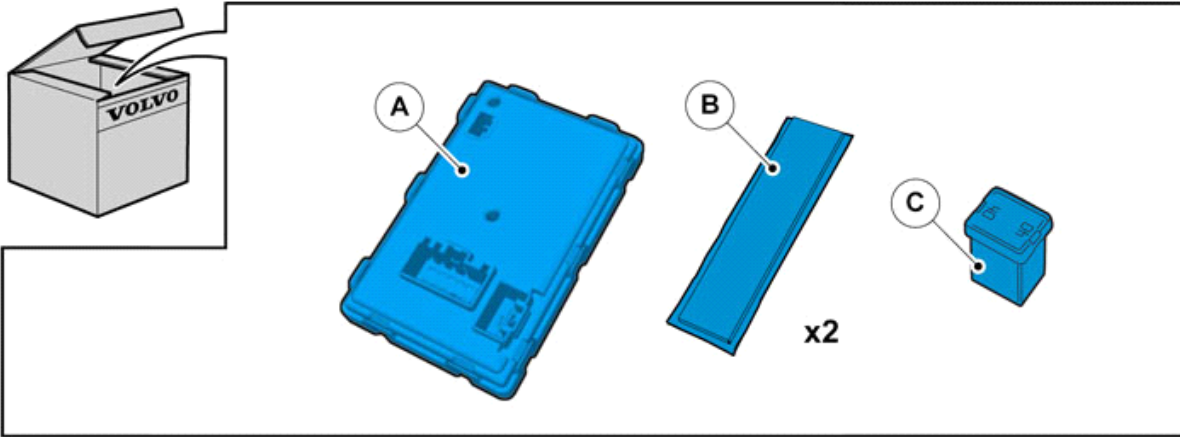

IMG-360181



Installation instructions, accessories

Volvo Car Corporation Gothenburg, Sweden

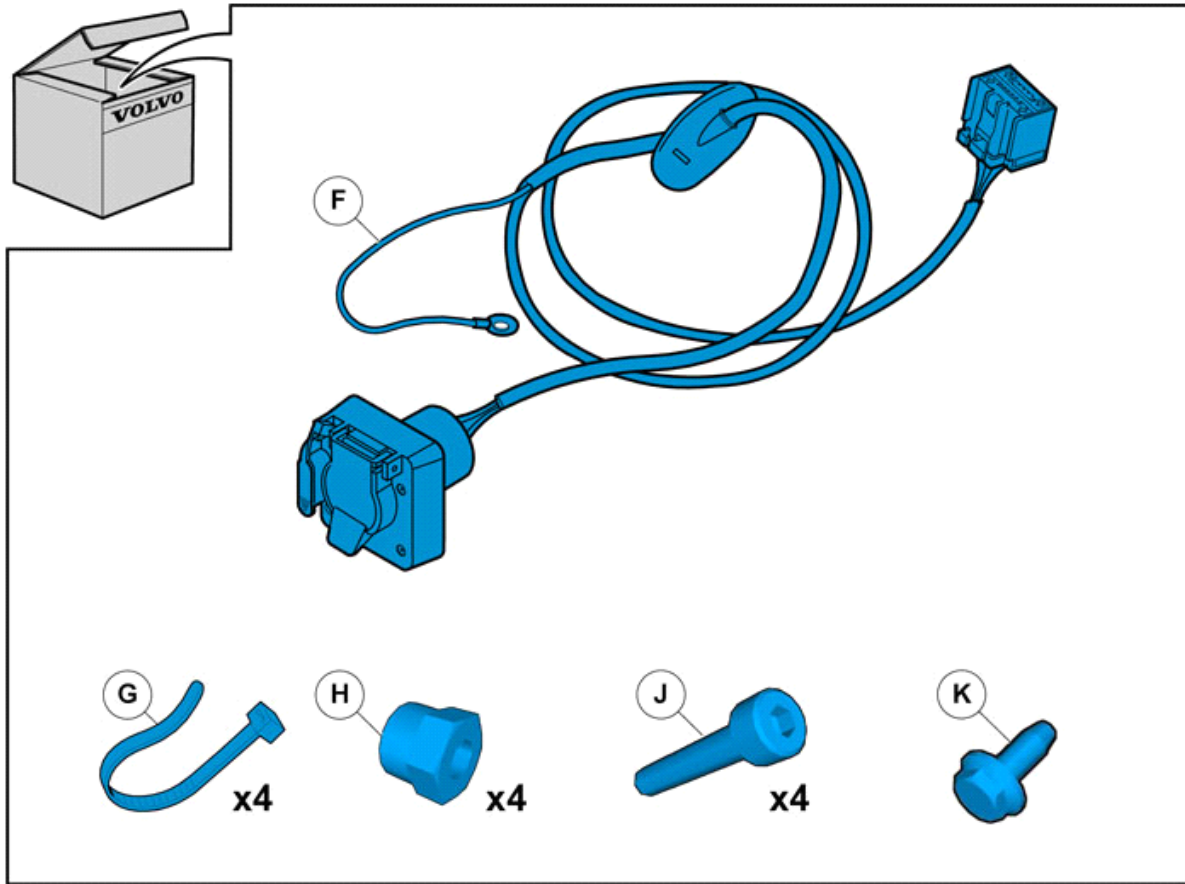

IMG-368477



Installation instructions, accessories

Volvo Car Corporation Gothenburg, Sweden

INTRODUCTION

Read through all of the instructions before starting installation.

Notifications and warning texts are for your safety and to minimise the risk of something breaking during installation.

Ensure that all tools stated in the instructions are available before starting installation.

Certain steps in the instructions are only presented in the form of images. Explanatory text is also given for more complicated steps.

In the event of any problems with the instructions or the accessory, contact your local Volvo dealer.

1

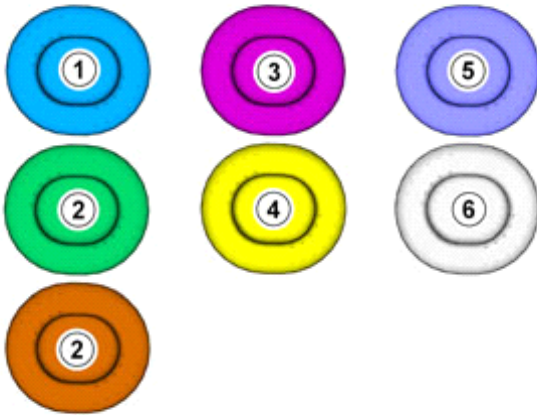

IMG-363036

Color symbols

1. Used for focused part, the part that you are to do something with.
2. Used as extra colors when you need to show or highlight additional parts.
3. Used for fasteners to be removed/installed. May be screws, clips, connectors, etc.
4. Used when part is not removed completely from the vehicle but is only hung/suspended off to the side.
5. Used for standard tools and special tools.
6. Used as background color on vehicle parts.



Installation instructions, accessories

Volvo Car Corporation Gothenburg, Sweden

2



Turn the ignition key to position **0**.

Note!

Wait at least three minutes before the connectors are unplugged or other electric equipment is removed.

IMG-245980

3

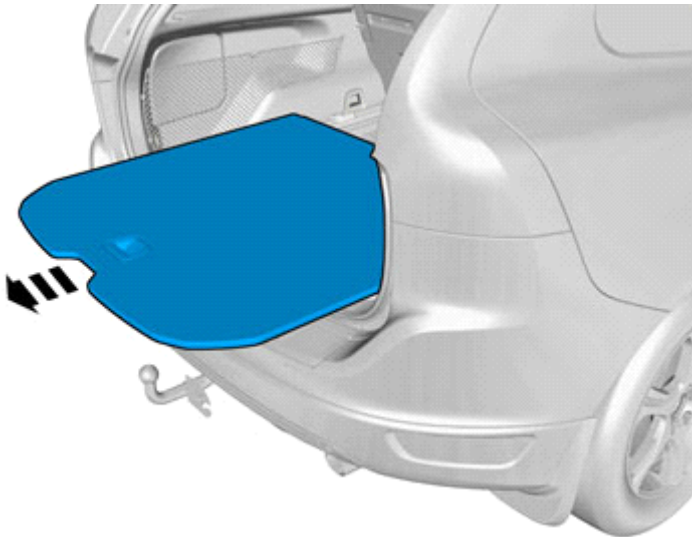

Removing

IMG-346921

4



IMG-346811



Installation instructions, accessories

Volvo Car Corporation Gothenburg, Sweden

5

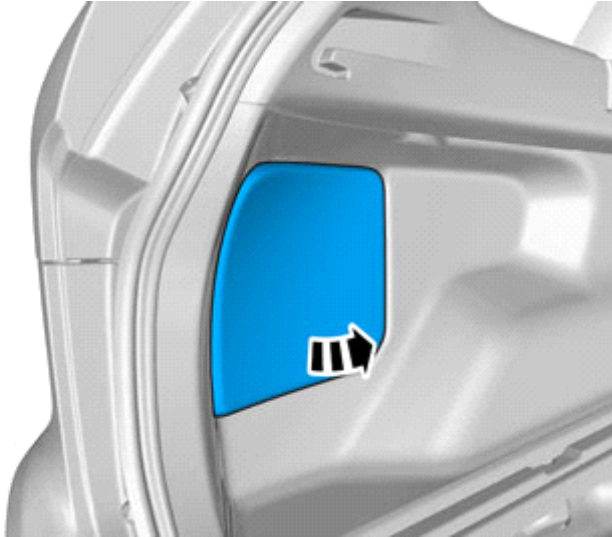

IMG-360187

Remove the panel.

6

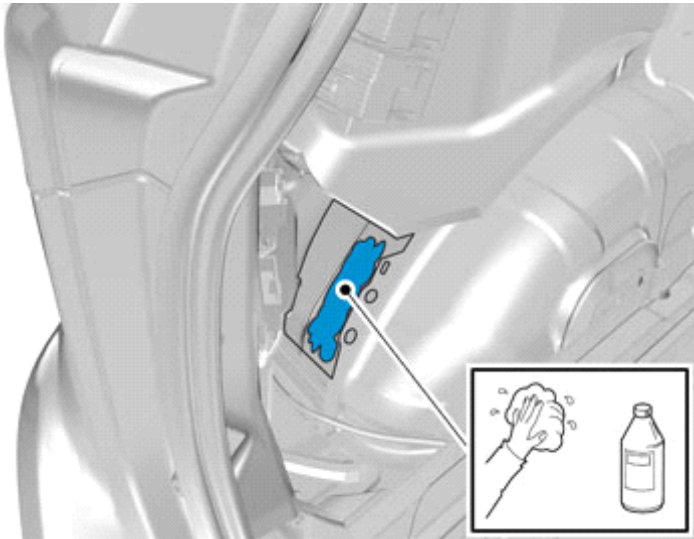

IMG-362267

Installing TRM

Use: Isopropanol, part number 1161721

Wipe dry.

7

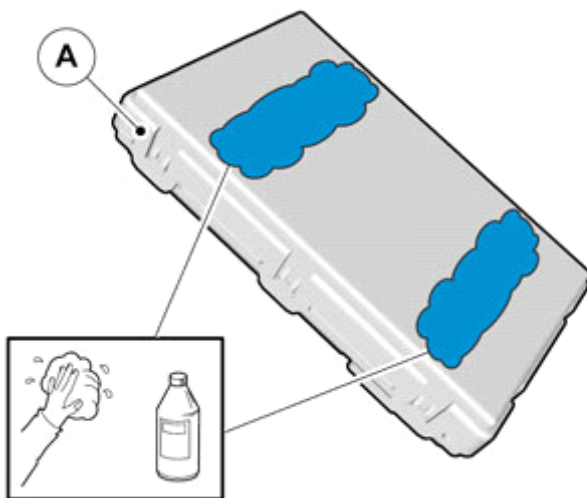

IMG-356179

Use: Isopropanol, part number 1161721

Wipe dry.



Installation instructions, accessories

Volvo Car Corporation Gothenburg, Sweden

8

Get the two Velcro straps from the kit and press them together, edge to edge.

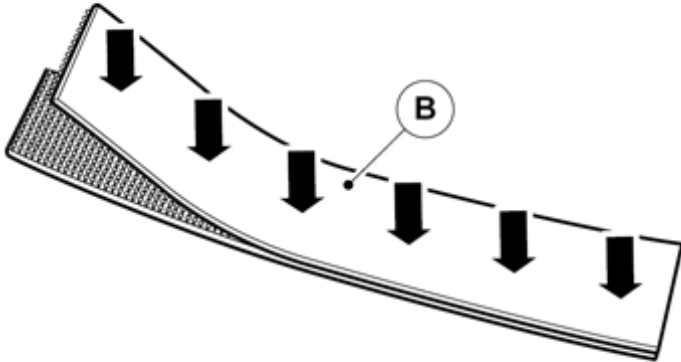

IMG-356181

9

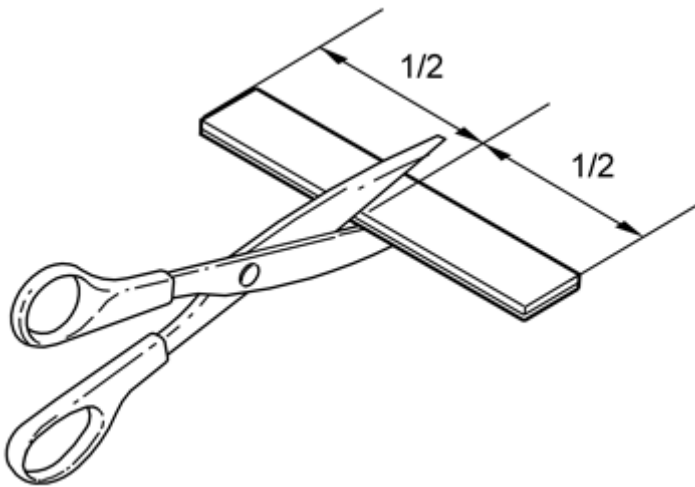

IMG-222282



Installation instructions, accessories

Volvo Car Corporation Gothenburg, Sweden

10

Remove the backing tape from one side of the Velcro straps.

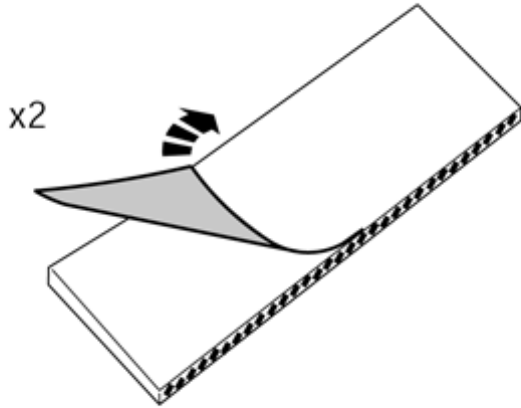

IMG-241925

11

When installing Velcro tape the surface must maintain a temperature of at least +20 ° C (68°F).

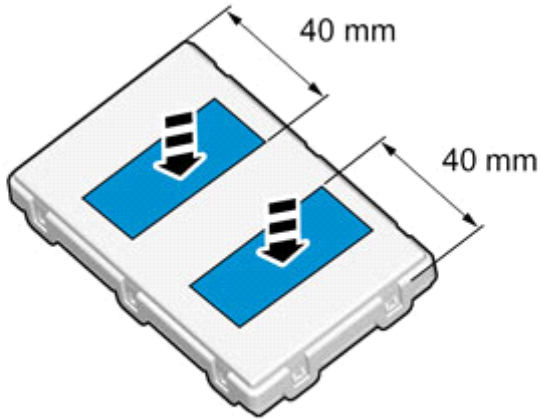

IMG-356351

12

Remove the masking tape

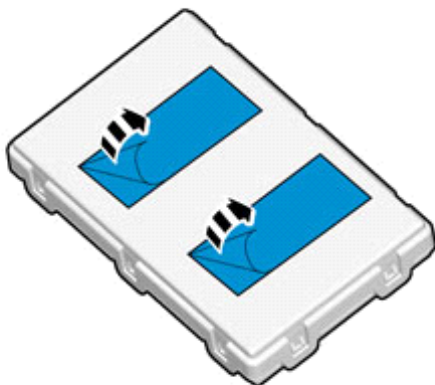

IMG-356352



Installation instructions, accessories

Volvo Car Corporation Gothenburg, Sweden

13

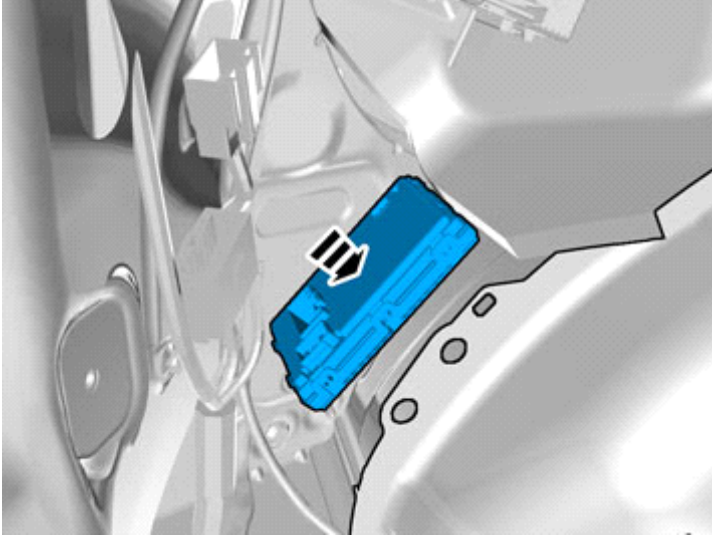

IMG-362292

Press the control module into place.

When installing Velcro tape the surface must maintain a temperature of at least +20 ° C (68°F).

14

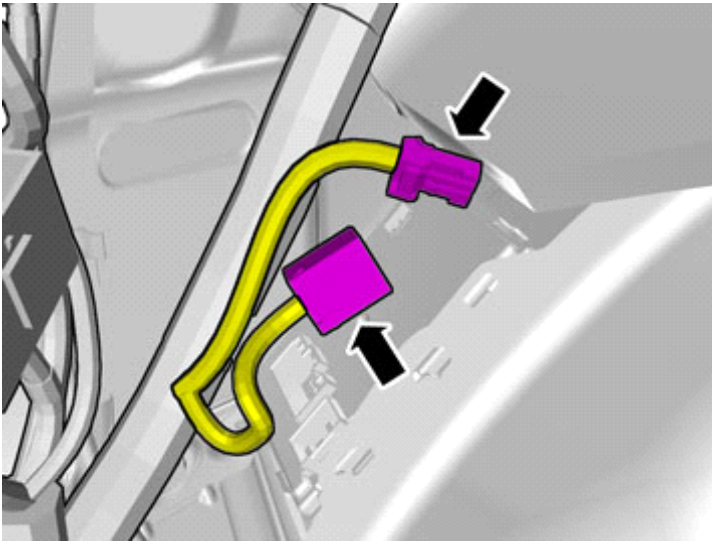

IMG-362298

Applies to cars model year from 2013-

Locate the connectors in the car's cable harness.

15

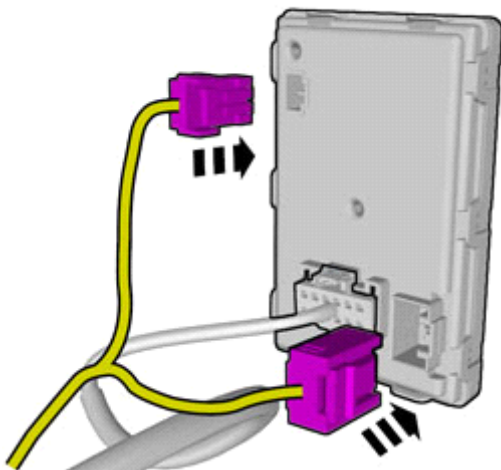

IMG-362296

Plug in the located connectors.



Installation instructions, accessories

Volvo Car Corporation Gothenburg, Sweden

16

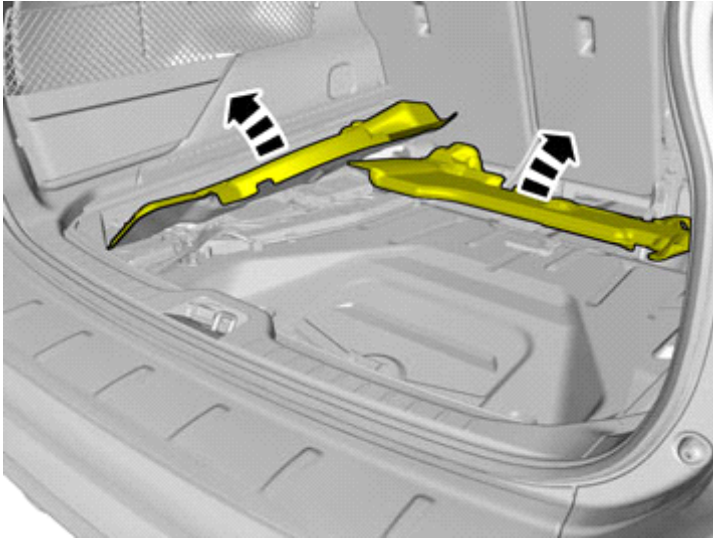

IMG-347027

Applies to cars model year up to and incl. -2012

Fold aside the insulation.

17

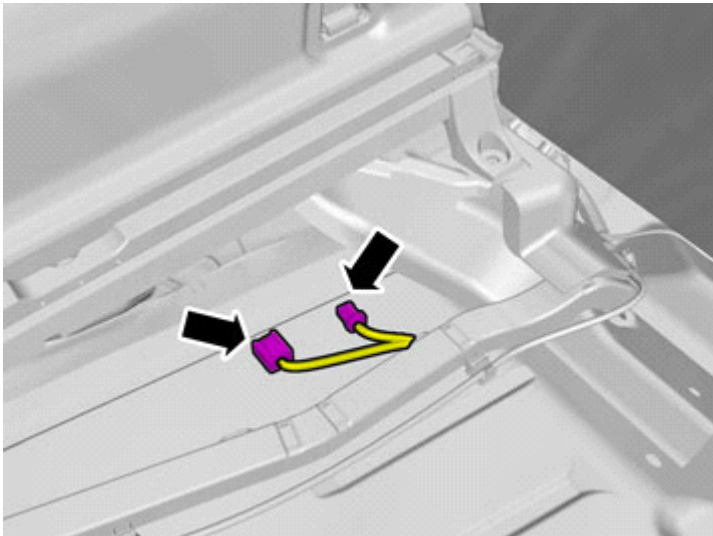

IMG-362307

Locate the connectors.



Installation instructions, accessories

Volvo Car Corporation Gothenburg, Sweden

18

Connect the extension cable harness to the located connectors.

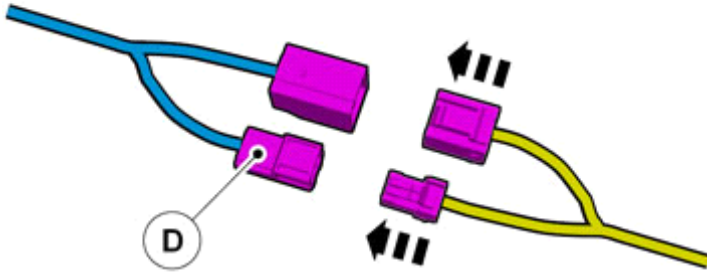

IMG-360183

19

Route the extension cable harness along the existing cable harness.

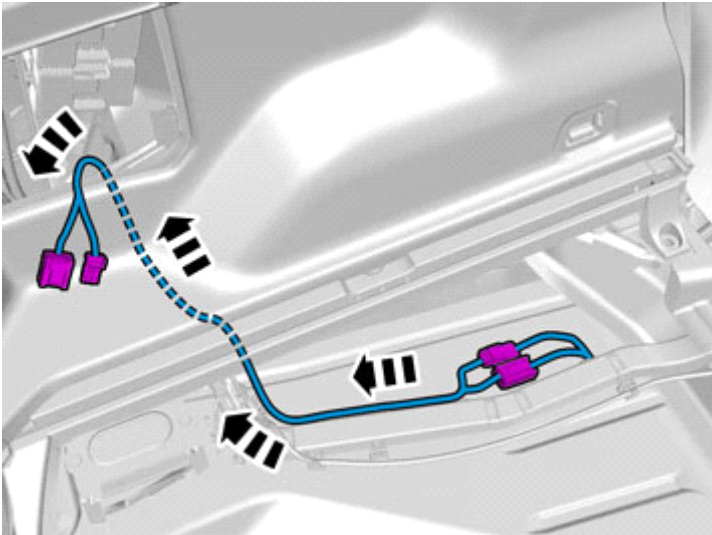

IMG-362318

20

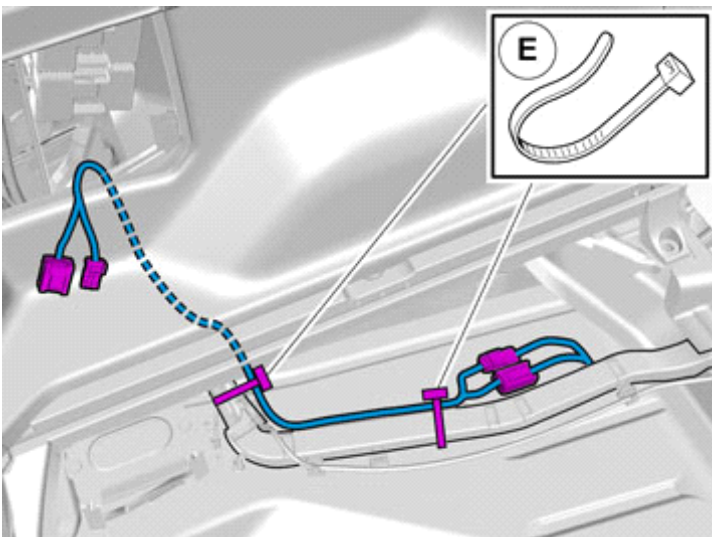

IMG-362319



Installation instructions, accessories

Volvo Car Corporation Gothenburg, Sweden

21

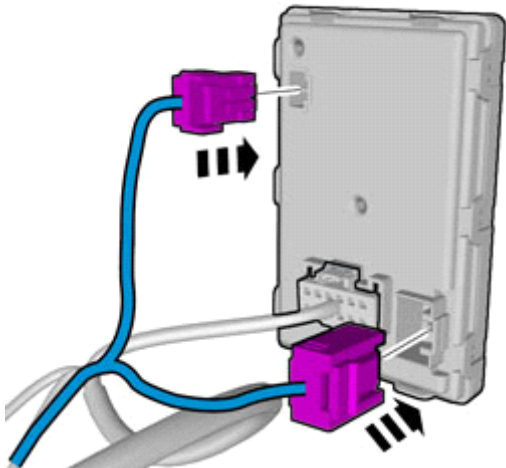

IMG-359922

Plug in the connectors from the extension cable harness to the control module.

22

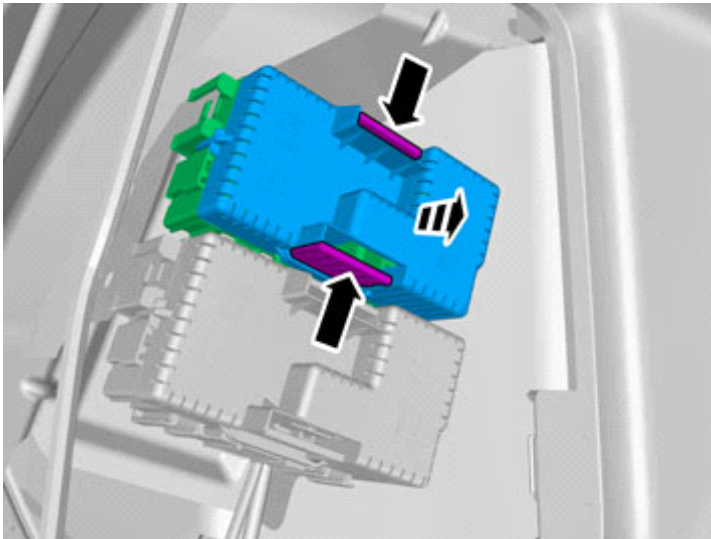

IMG-360189

All vehicles

Press in the catches on the black lid on the fuse holder and remove it.

23

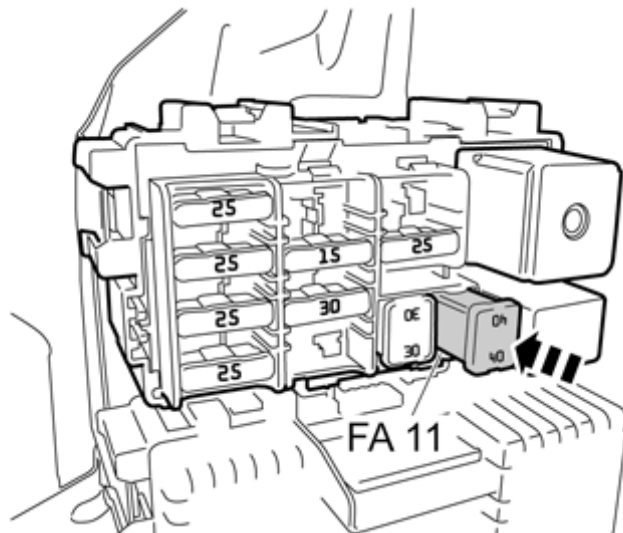

IMG-285841

Install 40A fuse in position FA 11 in module RJB-A.

Reinstall the cover.



Installation instructions, accessories

Volvo Car Corporation Gothenburg, Sweden

24

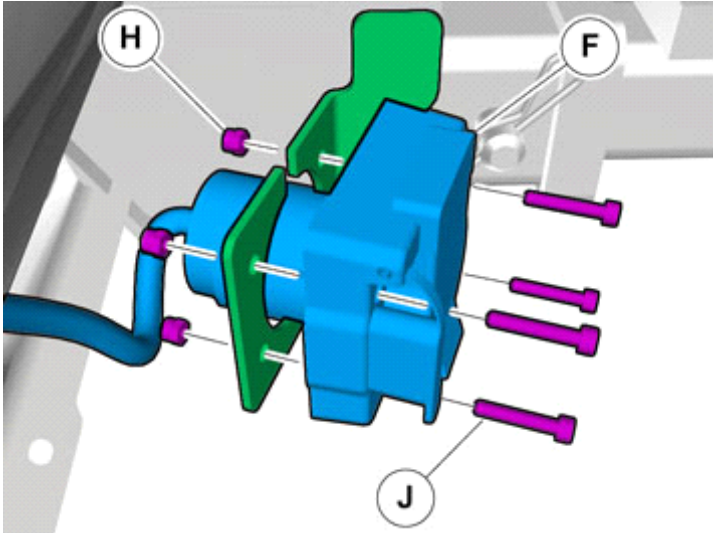

IMG-368513

Installing trailer hitch cable harness

25

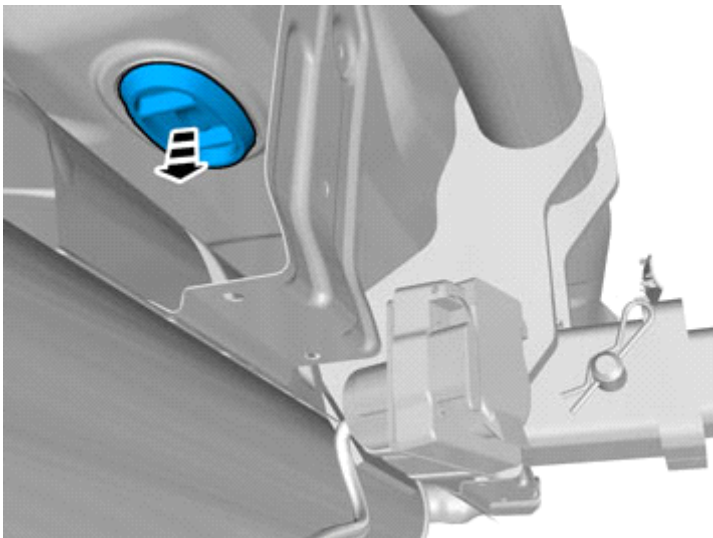

IMG-368519

Remove the rubber bushing in the floor and put it aside, it is not to be used anymore.



Installation instructions, accessories

Volvo Car Corporation Gothenburg, Sweden

26

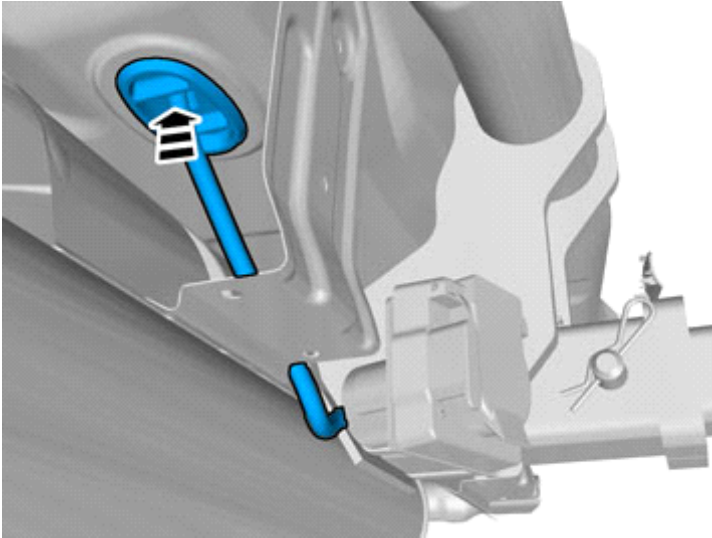

IMG-368522

Note!

The rubber bushing should be installed so that the cable points to the left on the inside.

Insert the cable with the connector in the hole in the spare wheel well and install the rubber bushing.

Adapt the length of the cable from the socket (outlet) and to the rubber bushing so that the cable is not too slack under the car.

27

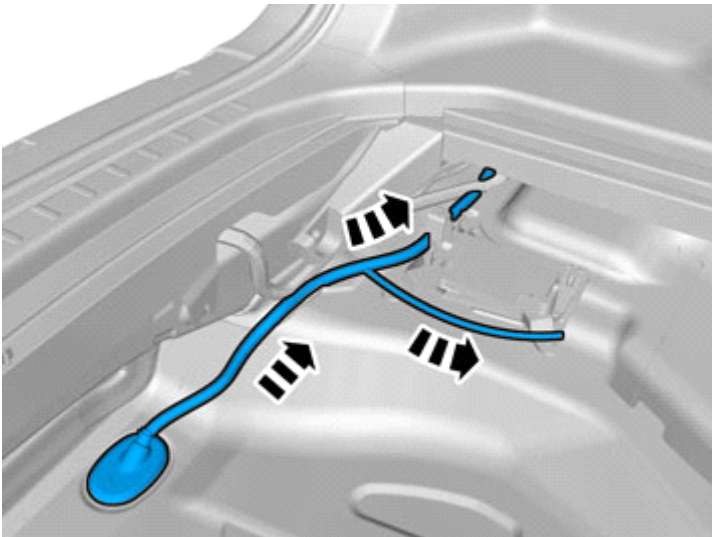

IMG-366117

28

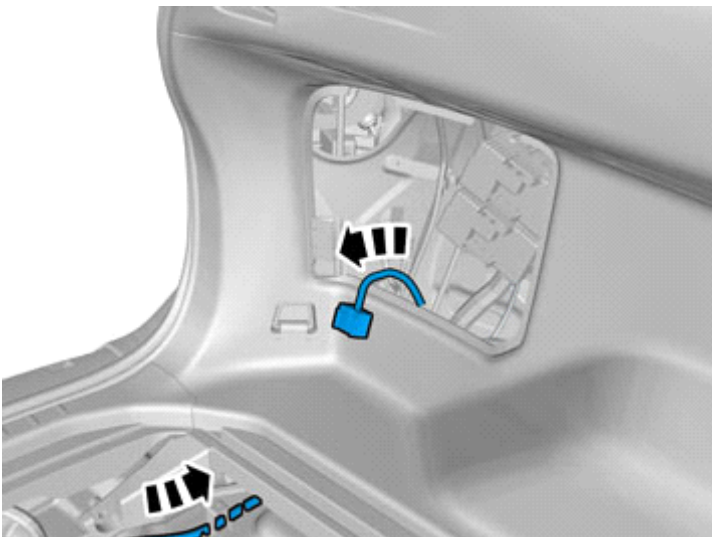

IMG-368533

Pull through the cable harness.



Installation instructions, accessories

Volvo Car Corporation Gothenburg, Sweden

29

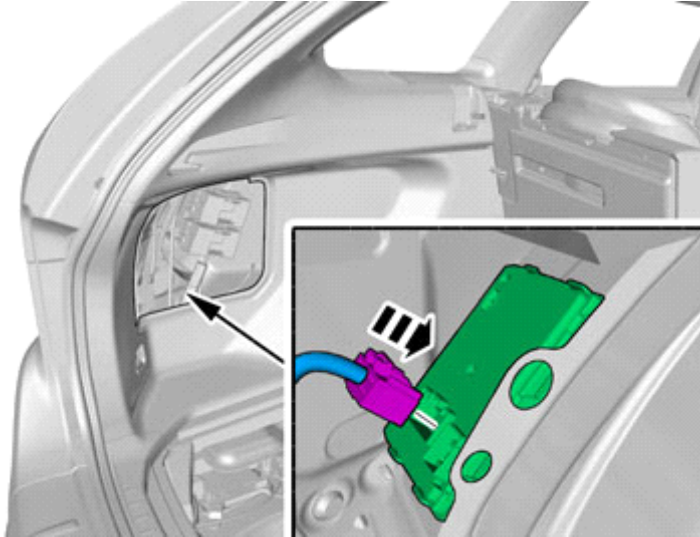

IMG-366072

Connect the connector.

30

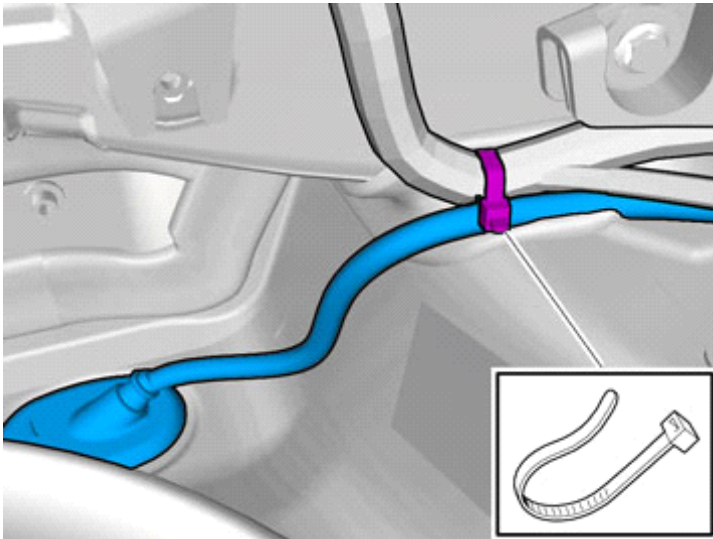

IMG-366316

31

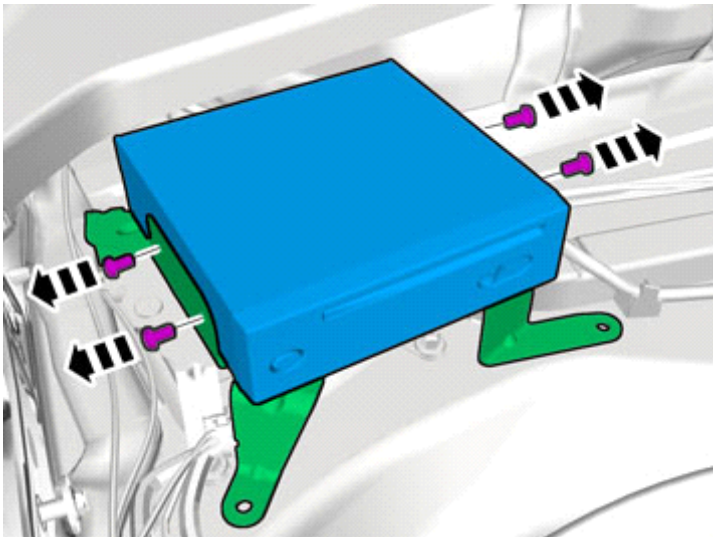

IMG-366140

Applies to vehicles with DVD-reader

Remove the screws.



Installation instructions, accessories

Volvo Car Corporation Gothenburg, Sweden

32

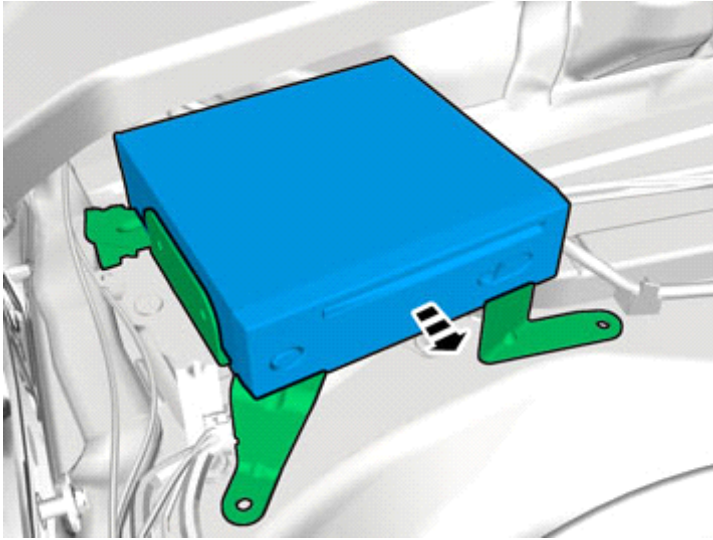

IMG-366142

33

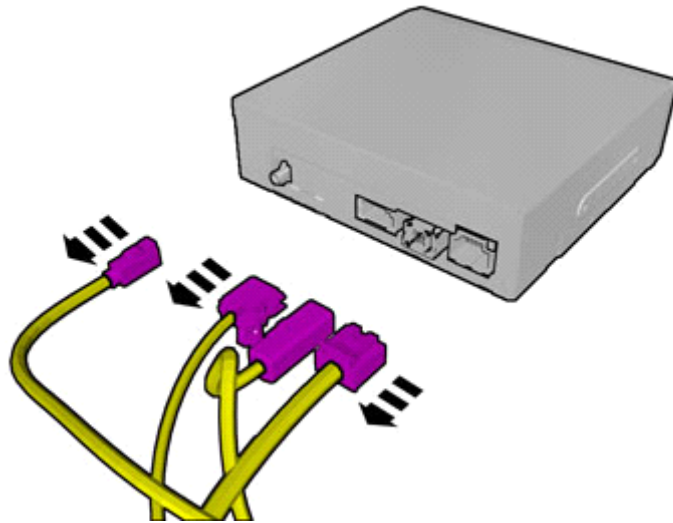

IMG-366146

Disconnect the connectors.



Installation instructions, accessories

Volvo Car Corporation Gothenburg, Sweden

34

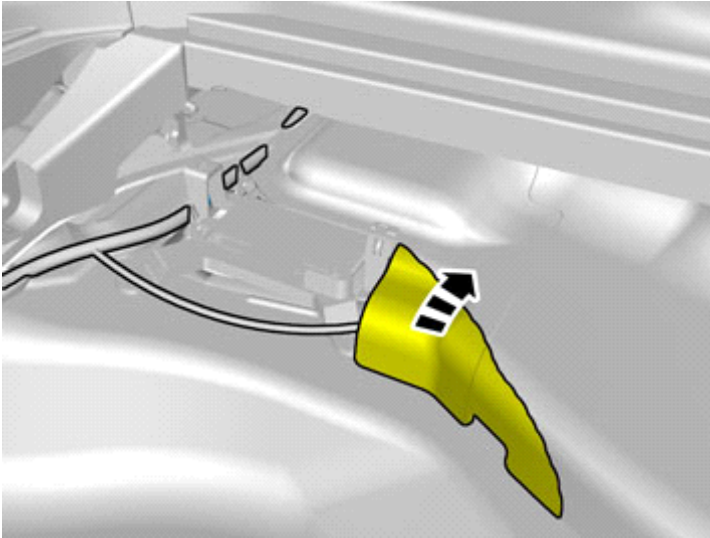

IMG-366124

Applies to all vehicles

Fold aside the insulation.

35

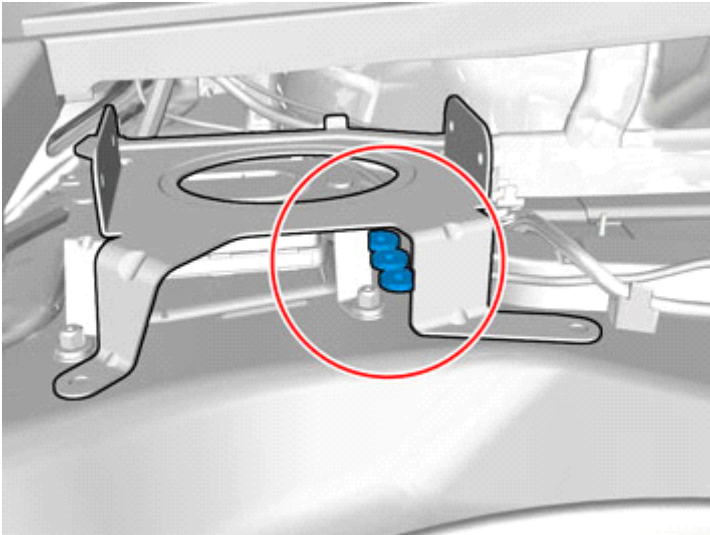

IMG-366276

Applies to vehicles with chassis number up to and incl. - 175378

Locate the grounding points.

36

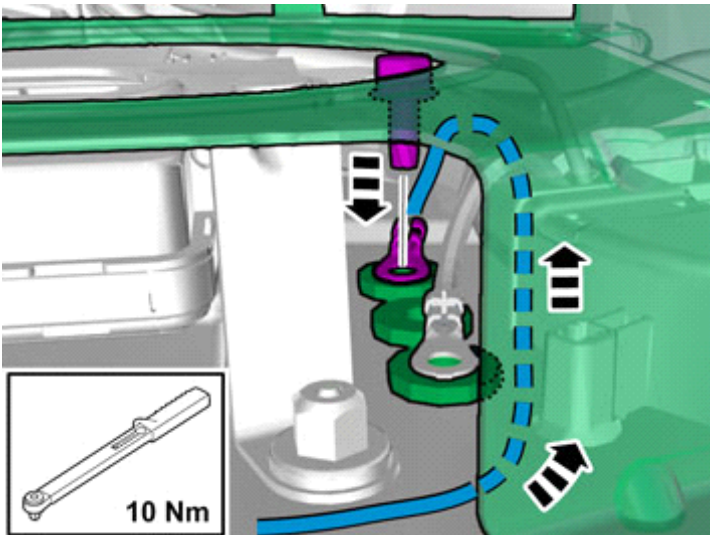

IMG-366471

Note!

Connect to a free grounding point, in one of the three existing.

Install the cable and ground screw Tightening torque: M6, 10 Nm



Installation instructions, accessories

Volvo Car Corporation Gothenburg, Sweden

37

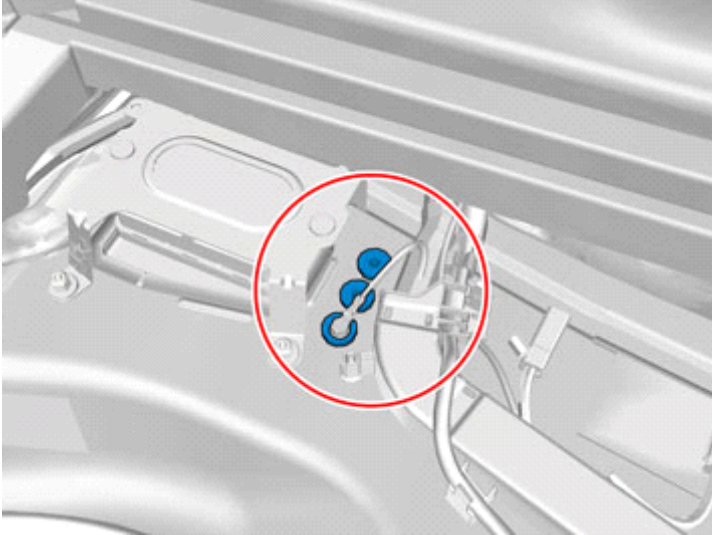

IMG-366473

Applies to vehicles with chassis number up to and incl. from 175379-

Locate the grounding points.

38

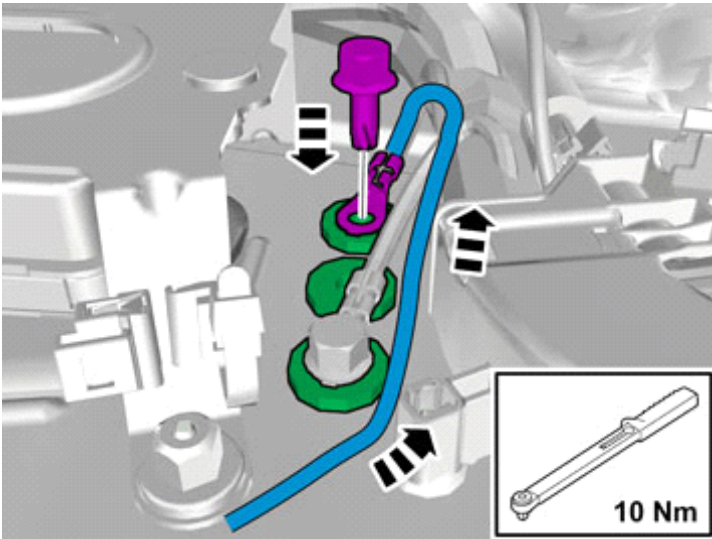

IMG-366131

Note!

Connect to a free grounding point, in one of the three existing.

Install the cable and ground screw Tightening torque: M6, 10 Nm

39

Applies to all vehicles

Reinstall the removed parts in reverse order.



Installation instructions, accessories

Volvo Car Corporation Gothenburg, Sweden

40

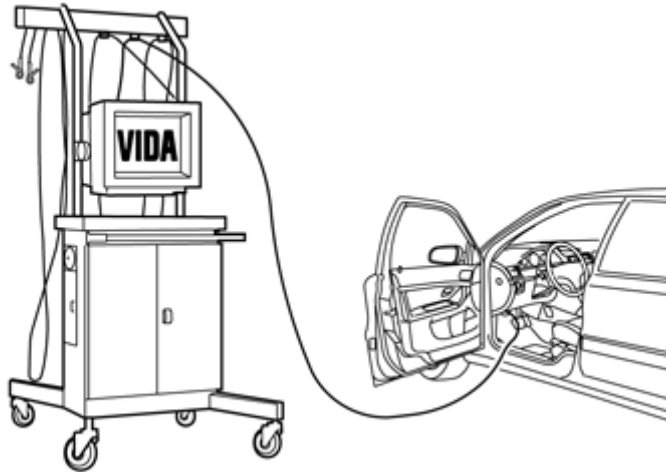

IMG-242268

Download software (application) for the accessory's function according to the service information in VIDA.

See VIDA or the accessories catalog for software part number

41

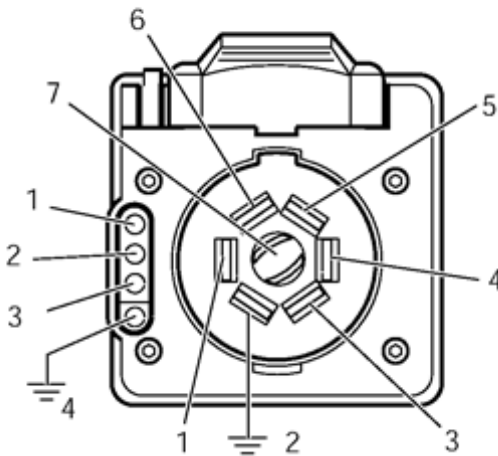

IMG-249951

Checking trailer socket

7-pin connection

1. Brake lights/Left turn signal
2. Ground
3. Spare (Brake lights, Electric brake)
4. Brake lights/Right turn signal
5. Charging
6. Running lights
7. Spare (Back-up light)

The cable for pin 3 for 7-pin connection is blue (BL). It is taped on the cable harness approx. 1 meter from the trailer socket.

4-pin connection

1. Brake lights/Right turn signal
2. Brake lights/Left turn signal
3. Running lights
4. Ground